

EE : ELECTRICAL ENGINEERING*Duration:* Three Hours*Maximum Marks:* 100**Read the following instructions carefully.**

1. Do not open the seal of the Question Booklet until you are asked to do so by the invigilator.
2. Take out the **Optical Response Sheet (ORS)** from this Question Booklet **without breaking the seal**. If you find that the Question Booklet Code printed at the right hand top corner of this page does not match with the Booklet Code on the **ORS**, exchange the booklet immediately with a new sealed Question Booklet.
3. Write your registration number, your name and name of the examination centre at the specified locations on the right half of the **ORS**. Also, using HB pencil, darken the appropriate bubble under each digit of your registration number and the letters corresponding to your test paper code (EE).
4. Write your name and registration number in the space provided at the bottom of this page.
5. This Booklet contains **24** pages including blank pages for rough work. After opening the seal at the specified time, please check all pages and report discrepancy, if any.
6. There are a total of 65 questions carrying 100 marks. All these questions are of objective type. Questions must be answered on the left hand side of the **ORS** by darkening the appropriate bubble (marked A, B, C, D) using HB pencil against the question number. **For each question darken the bubble of the correct answer**. In case you wish to change an answer, erase the old answer completely. More than one answer bubbled against a question will be treated as an incorrect response.
7. Questions Q.1 – Q.25 carry 1-mark each, and questions Q.26 – Q.55 carry 2-marks each.
8. Questions Q.48 – Q.51 (2 pairs) are common data questions and question pairs (Q.52, Q.53) and (Q.54, Q.55) are linked answer questions. The answer to the second question of the linked answer questions depends on the answer to the first question of the pair. If the first question in the linked pair is wrongly answered or is unattempted, then the answer to the second question in the pair will not be evaluated.
9. Questions Q.56 – Q.65 belong to General Aptitude (GA). Questions Q.56 – Q.60 carry 1-mark each, and questions Q.61 – Q.65 carry 2-marks each. The GA questions begin on a fresh page starting from page 17.
10. Unattempted questions will result in zero mark and wrong answers will result in **NEGATIVE** marks. For Q.1 – Q.25 and Q.56 – Q.60, $\frac{1}{3}$ mark will be deducted for each wrong answer. For Q.26 – Q.51 and Q.61 – Q.65, $\frac{2}{3}$ mark will be deducted for each wrong answer. The question pairs (Q.52, Q.53), and (Q.54, Q.55) are questions with linked answers. There will be negative marks only for wrong answer to the first question of the linked answer question pair, i.e. for Q.52 and Q.54, $\frac{2}{3}$ mark will be deducted for each wrong answer. There is no negative marking for Q.53 and Q.55.
11. Calculator is allowed whereas charts, graph sheets or tables are **NOT** allowed in the examination hall.
12. Rough work can be done on the question paper itself. Additionally, blank pages are provided at the end of the question paper for rough work.

Name								
Registration Number	EE							

Q. 1 – Q. 25 carry one mark each.

Q.1 Roots of the algebraic equation $x^3 + x^2 + x + 1 = 0$ are

- (A) $(+1, +j, -j)$ (B) $(+1, -1, +1)$ (C) $(0, 0, 0)$ (D) $(-1, +j, -j)$

Q.2 With K as a constant, the possible solution for the first order differential equation $\frac{dy}{dx} = e^{-3x}$ is

- (A) $-\frac{1}{3}e^{-3x} + K$ (B) $-\frac{1}{3}e^{3x} + K$ (C) $-3e^{-3x} + K$ (D) $-3e^{-x} + K$

Q.3 The r.m.s value of the current $i(t)$ in the circuit shown below is

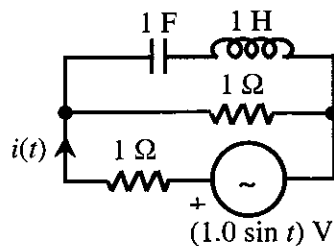

- (A) $\frac{1}{2}$ A (B) $\frac{1}{\sqrt{2}}$ A (C) 1 A (D) $\sqrt{2}$ A

Q.4 The Fourier series expansion $f(t) = a_0 + \sum_{n=1}^{\infty} a_n \cos n\omega t + b_n \sin n\omega t$ of the periodic signal shown below will contain the following nonzero terms

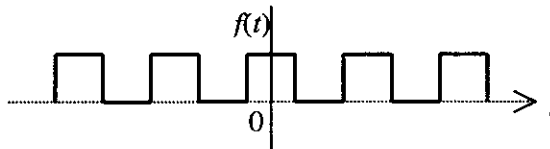

- (A) a_0 and $b_n, n = 1, 3, 5, \dots \infty$ (B) a_0 and $a_n, n = 1, 2, 3, \dots \infty$
 (C) a_0, a_n and $b_n, n = 1, 2, 3, \dots \infty$ (D) a_0 and $a_n, n = 1, 3, 5, \dots \infty$

Q.5 A 4-point starter is used to start and control the speed of a

- (A) dc shunt motor with armature resistance control
 (B) dc shunt motor with field weakening control
 (C) dc series motor
 (D) dc compound motor

Q.6 A three-phase, salient pole synchronous motor is connected to an infinite bus. It is operated at no load at normal excitation. The field excitation of the motor is first reduced to zero and then increased in the reverse direction gradually. Then the armature current

- (A) increases continuously (B) first increases and then decreases steeply
 (C) first decreases and then increases steeply (D) remains constant

Q.7 A nuclear power station of 500 MW capacity is located at 300 km away from a load center. Select the most suitable power evacuation transmission configuration among the following options

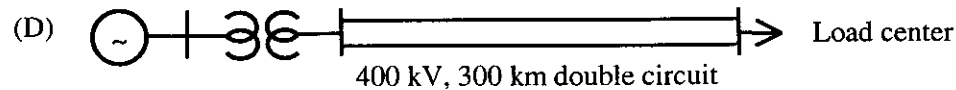
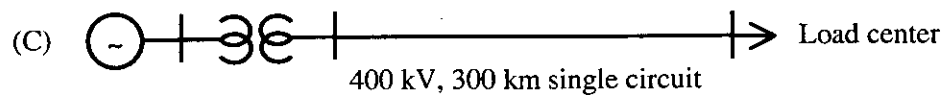
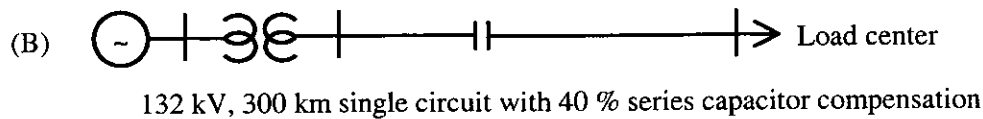
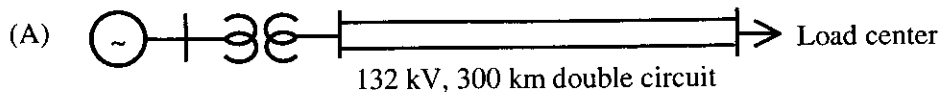

Q.8 The frequency response of a linear system $G(j\omega)$ is provided in the tabular form below

$ G(j\omega) $	1.3	1.2	1.0	0.8	0.5	0.3
$\angle G(j\omega)$	-130°	-140°	-150°	-160°	-180°	-200°

The gain margin and phase margin of the system are

- (A) 6 dB and 30° (B) 6 dB and -30° (C) -6 dB and 30° (D) -6 dB and -30°

Q.9 The steady state error of a unity feedback linear system for a unit step input is 0.1. The steady state error of the same system, for a pulse input $r(t)$ having a magnitude of 10 and a duration of one second, as shown in the figure is

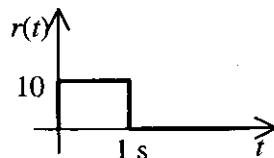

- (A) 0 (B) 0.1 (C) 1 (D) 10

Q.10 Consider the following statements:

- (i) The compensating coil of a low power factor wattmeter compensates the effect of the impedance of the current coil.
 (ii) The compensating coil of a low power factor wattmeter compensates the effect of the impedance of the voltage coil circuit.

- (A) (i) is true but (ii) is false (B) (i) is false but (ii) is true
 (C) both (i) and (ii) are true (D) both (i) and (ii) are false

- Q.11 A low-pass filter with a cut-off frequency of 30 Hz is cascaded with a high-pass filter with a cut-off frequency of 20 Hz. The resultant system of filters will function as
- (A) an all-pass filter
 (B) an all-stop filter
 (C) a band stop (band-reject) filter
 (D) a band-pass filter

Q.12 For the circuit shown below,

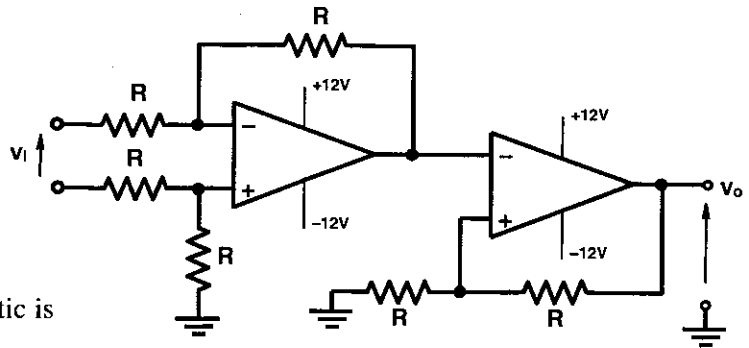

the **CORRECT** transfer characteristic is

(A)

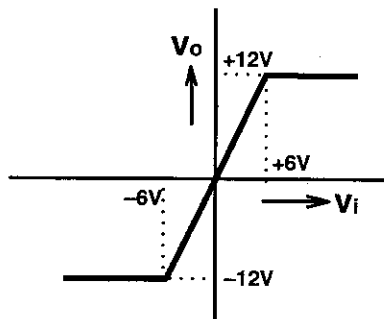

(B)

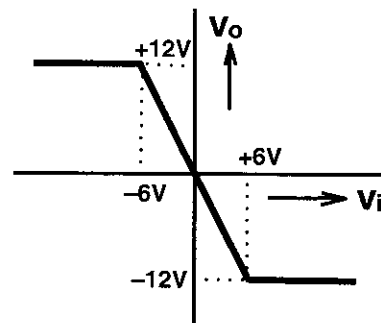

(C)

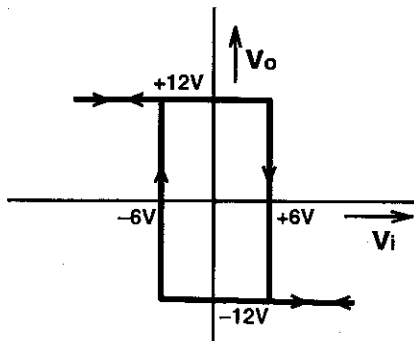

(D)

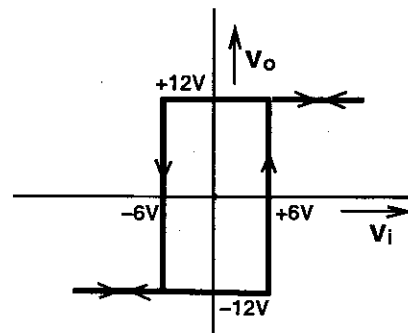

Q.13 A three-phase current source inverter used for the speed control of an induction motor is to be realized using MOSFET switches as shown below. Switches S_1 to S_6 are identical switches.

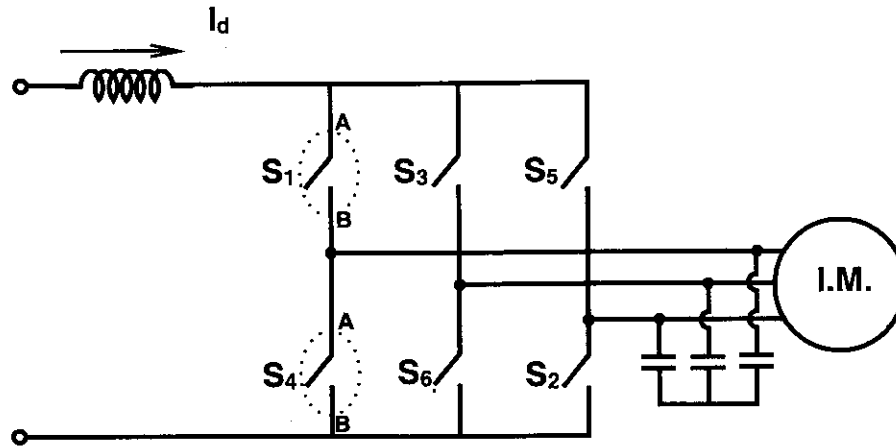

The proper configuration for realizing switches S_1 to S_6 is

- (A) (B) (C) (D)

Q.14 A point z has been plotted in the complex plane, as shown in figure below.

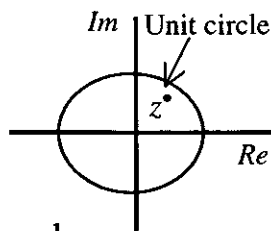

The plot of the complex number $y = \frac{1}{z}$ is

- (A) (B) (C) (D)

Q.15 The voltage applied to a circuit is $100\sqrt{2} \cos(100\pi t)$ volts and the circuit draws a current of $10\sqrt{2} \sin(100\pi t + \pi/4)$ amperes. Taking the voltage as the reference phasor, the phasor representation of the current in amperes is

- (A) $10\sqrt{2} \angle -\pi/4$ (B) $10 \angle -\pi/4$ (C) $10 \angle +\pi/4$ (D) $10\sqrt{2} \angle +\pi/4$

Q.16 In the circuit given below, the value of R required for the transfer of maximum power to the load having a resistance of 3Ω is

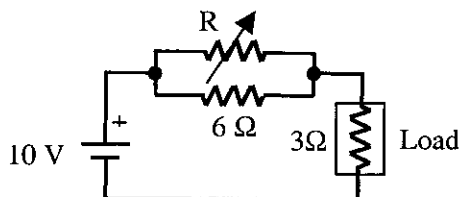

- (A) zero (B) 3Ω (C) 6Ω (D) infinity

Q.17 Given two continuous time signals $x(t) = e^{-t}$ and $y(t) = e^{-2t}$ which exist for $t > 0$, the convolution $z(t) = x(t) * y(t)$ is

- (A) $e^{-t} - e^{-2t}$ (B) e^{-3t} (C) e^{+t} (D) $e^{-t} + e^{-2t}$

Q.18 A single-phase air core transformer, fed from a rated sinusoidal supply, is operating at no load. The steady state magnetizing current drawn by the transformer from the supply will have the waveform

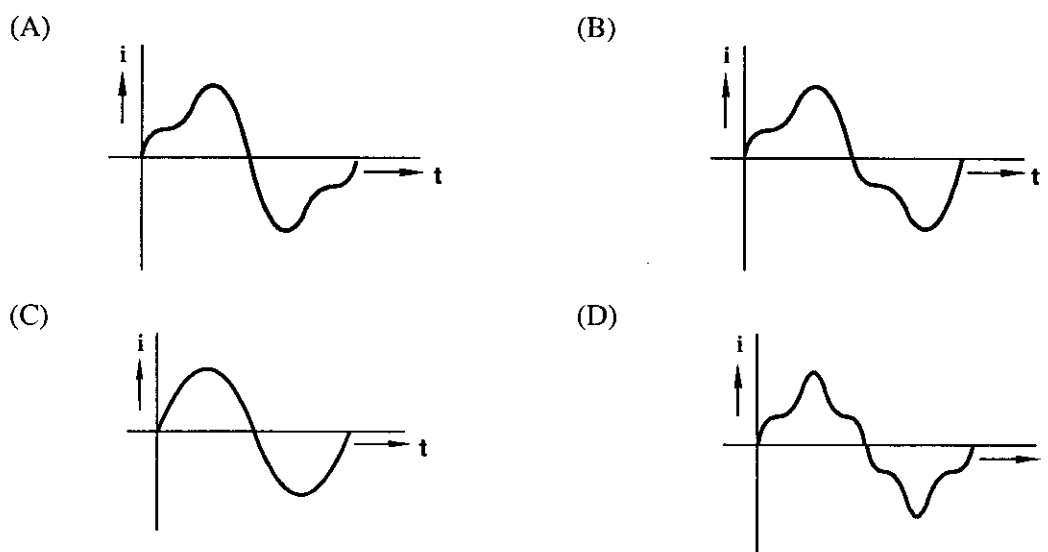

Q.19 A negative sequence relay is commonly used to protect

- (A) an alternator (B) a transformer (C) a transmission line (D) a bus bar

Q.20 For enhancing the power transmission in a long EHV transmission line, the most preferred method is to connect a

- (A) series inductive compensator in the line
- (B) shunt inductive compensator at the receiving end
- (C) series capacitive compensator in the line
- (D) shunt capacitive compensator at the sending end

Q.21 An open loop system represented by the transfer function $G(s) = \frac{(s-1)}{(s+2)(s+3)}$ is

- (A) stable and of the minimum phase type
- (B) stable and of the non-minimum phase type
- (C) unstable and of the minimum phase type
- (D) unstable and of the non-minimum phase type

Q.22 The bridge circuit shown in the figure below is used for the measurement of an unknown element Z_x . The bridge circuit is best suited when Z_x is a

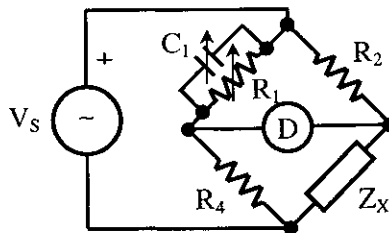

- (A) low resistance
- (B) high resistance
- (C) low Q inductor
- (D) lossy capacitor

Q.23 A dual trace oscilloscope is set to operate in the ALternate mode. The control input of the multiplexer used in the y-circuit is fed with a signal having a frequency equal to

- (A) the highest frequency that the multiplexer can operate properly
- (B) twice the frequency of the time base (sweep) oscillator
- (C) the frequency of the time base (sweep) oscillator
- (D) half the frequency of the time base (sweep) oscillator

Q.24 The output Y of the logic circuit given below is

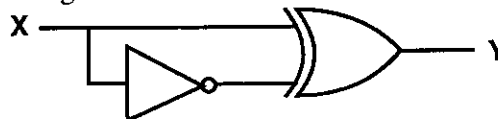

- (A) 1
- (B) 0
- (C) X
- (D) \bar{X}

Q.25 *Circuit turn-off time* of an SCR is defined as the time

- (A) taken by the SCR to turn off
- (B) required for the SCR current to become zero
- (C) for which the SCR is reverse biased by the commutation circuit
- (D) for which the SCR is reverse biased to reduce its current below the holding current

Q. 26 to Q. 55 carry two marks each.

- Q.26 Solution of the variables x_1 and x_2 for the following equations is to be obtained by employing the Newton-Raphson iterative method.

equation (i) $10x_2 \sin x_1 - 0.8 = 0$

equation (ii) $10x_2^2 - 10x_2 \cos x_1 - 0.6 = 0$

Assuming the initial values $x_1 = 0.0$ and $x_2 = 1.0$, the Jacobian matrix is

(A) $\begin{bmatrix} 10 & -0.8 \\ 0 & -0.6 \end{bmatrix}$ (B) $\begin{bmatrix} 10 & 0 \\ 0 & 10 \end{bmatrix}$ (C) $\begin{bmatrix} 0 & -0.8 \\ 10 & -0.6 \end{bmatrix}$ (D) $\begin{bmatrix} 10 & 0 \\ 10 & -10 \end{bmatrix}$

- Q.27 The function $f(x) = 2x - x^2 + 3$ has

- (A) a *maxima* at $x = 1$ and a *minima* at $x = 5$ (B) a *maxima* at $x = 1$ and a *minima* at $x = -5$
 (C) only a *maxima* at $x = 1$ (D) only a *minima* at $x = 1$

- Q.28 A lossy capacitor C_x , rated for operation at 5 kV, 50 Hz is represented by an equivalent circuit with an ideal capacitor C_p in parallel with a resistor R_p . The value of C_p is found to be $0.102 \mu\text{F}$ and the value of $R_p = 1.25 \text{ M}\Omega$. Then the power loss and $\tan \delta$ of the lossy capacitor operating at the rated voltage, respectively, are

- (A) 10 W and 0.0002 (B) 10 W and 0.0025 (C) 20 W and 0.025 (D) 20 W and 0.04

- Q.29 Let the Laplace transform of a function $f(t)$ which exists for $t > 0$ be $F_1(s)$ and the Laplace transform of its delayed version $f(t - \tau)$ be $F_2(s)$. Let $F_1^*(s)$ be the complex conjugate of $F_1(s)$ with the Laplace variable set as $s = \sigma + j\omega$. If $G(s) = \frac{F_2(s) \cdot F_1^*(s)}{|F_1(s)|^2}$, then the inverse Laplace transform of $G(s)$ is

- (A) an ideal impulse $\delta(t)$ (B) an ideal delayed impulse $\delta(t - \tau)$
 (C) an ideal step function $u(t)$ (D) an ideal delayed step function $u(t - \tau)$

- Q.30 A zero mean random signal is uniformly distributed between limits $-a$ and $+a$ and its mean square value is equal to its variance. Then the r.m.s value of the signal is

- (A) $\frac{a}{\sqrt{3}}$ (B) $\frac{a}{\sqrt{2}}$ (C) $a\sqrt{2}$ (D) $a\sqrt{3}$

- Q.31 A 220 V, DC shunt motor is operating at a speed of 1440 rpm. The armature resistance is 1.0Ω and armature current is 10 A. If the excitation of the machine is reduced by 10 %, the extra resistance to be put in the armature circuit to maintain the same speed and torque will be

- (A) 1.79Ω (B) 2.1Ω (C) 3.1Ω (D) 18.9Ω

- Q.32 A load center of 120 MW derives power from two power stations connected by 220 kV transmission lines of 25 km and 75 km as shown in the figure below. The three generators G1, G2 and G3 are of 100 MW capacity each and have identical fuel cost characteristics. The *minimum loss generation schedule* for supplying the 120 MW load is

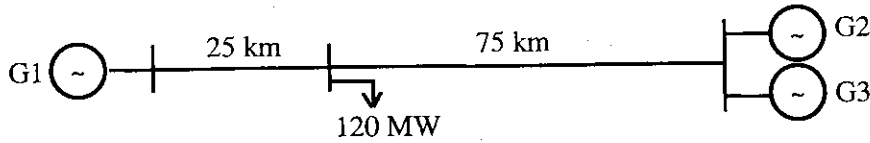

- (A) P1 = 80 MW + losses
P2 = 20 MW
P3 = 20 MW
- (B) P1 = 60 MW
P2 = 30 MW + losses
P3 = 30 MW
- (C) P1 = 40 MW
P2 = 40 MW
P3 = 40 MW + losses
- (D) P1 = 30 MW + losses
P2 = 45 MW
P3 = 45 MW
- Q.33 The open loop transfer function $G(s)$ of a unity feedback control system is given as,

$$G(s) = \frac{k \left(s + \frac{2}{3} \right)}{s^2 (s + 2)}$$

From the root locus, it can be inferred that when k tends to positive infinity,

- (A) three roots with nearly equal real parts exist on the left half of the s -plane
 (B) one real root is found on the right half of the s -plane
 (C) the root loci cross the $j\omega$ axis for a finite value of k ; $k \neq 0$
 (D) three real roots are found on the right half of the s -plane
- Q.34 A portion of the main program to call a subroutine SUB in an 8085 environment is given below.

```

:
:
LXI  D, DISP
LP:  CALL SUB
:
:

```

It is desired that control be returned to LP + DISP + 3 when the RET instruction is executed in the subroutine. The set of instructions that precede the RET instruction in the subroutine are

- (A) POP D (B) POP H (C) POP H (D) XTHL
 DAD H DAD D DAD D INX D
 PUSH D INX H PUSH H INX D
 INX H INX D
 INX H XTHL
 PUSH H

Q.35 The transistor used in the circuit shown below has a β of 30 and I_{CBO} is negligible.

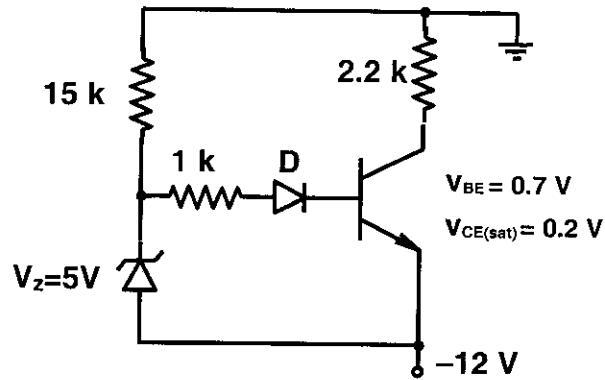

If the forward voltage drop of diode is 0.7 V , then the current through collector will be
 (A) 168 mA (B) 108 mA (C) 20.54 mA (D) 5.36 mA

Q.36 A voltage commutated chopper circuit, operated at 500 Hz , is shown below.

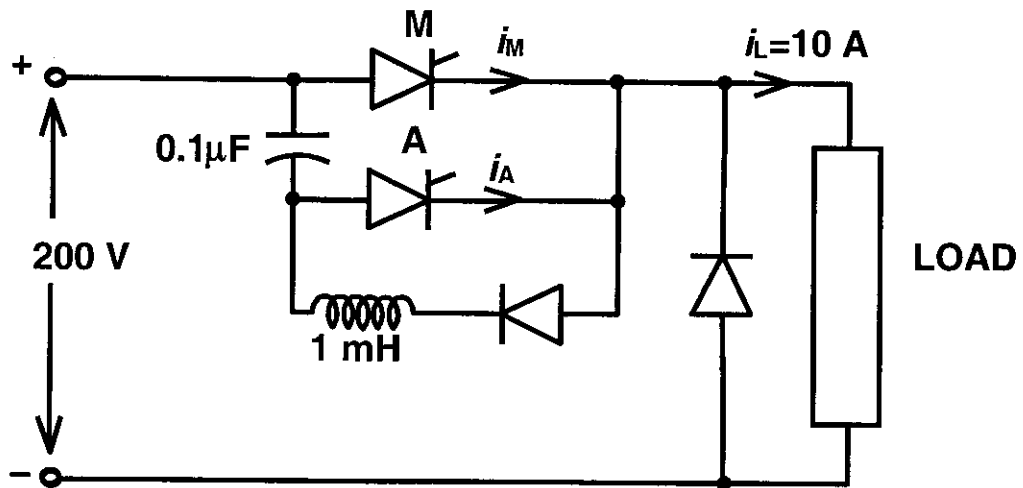

If the maximum value of load current is 10 A , then the maximum current through the main (M) and auxiliary (A) thyristors will be

- (A) $i_{M\text{max}} = 12\text{ A}$ and $i_{A\text{max}} = 10\text{ A}$ (B) $i_{M\text{max}} = 12\text{ A}$ and $i_{A\text{max}} = 2\text{ A}$
 (C) $i_{M\text{max}} = 10\text{ A}$ and $i_{A\text{max}} = 12\text{ A}$ (D) $i_{M\text{max}} = 10\text{ A}$ and $i_{A\text{max}} = 8\text{ A}$

Q.37 The matrix $[A] = \begin{bmatrix} 2 & 1 \\ 4 & -1 \end{bmatrix}$ is decomposed into a product of a lower triangular matrix $[L]$ and an upper triangular matrix $[U]$. The properly decomposed $[L]$ and $[U]$ matrices respectively are

(A) $\begin{bmatrix} 1 & 0 \\ 4 & -1 \end{bmatrix}$ and $\begin{bmatrix} 1 & 1 \\ 0 & -2 \end{bmatrix}$

(B) $\begin{bmatrix} 2 & 0 \\ 4 & -1 \end{bmatrix}$ and $\begin{bmatrix} 1 & 1 \\ 0 & 1 \end{bmatrix}$

(C) $\begin{bmatrix} 1 & 0 \\ 4 & 1 \end{bmatrix}$ and $\begin{bmatrix} 2 & 1 \\ 0 & -1 \end{bmatrix}$

(D) $\begin{bmatrix} 2 & 0 \\ 4 & -3 \end{bmatrix}$ and $\begin{bmatrix} 1 & 0.5 \\ 0 & 1 \end{bmatrix}$

Q.38 The two vectors $[1, 1, 1]$ and $[1, a, a^2]$, where $a = \left(-\frac{1}{2} + j\frac{\sqrt{3}}{2}\right)$, are

(A) orthonormal

(B) orthogonal

(C) parallel

(D) collinear

Q.39 A three-phase 440V, 6 pole, 50Hz, squirrel cage induction motor is running at a slip of 5%. The speed of stator magnetic field with respect to rotor magnetic field and speed of rotor with respect to stator magnetic field are

(A) zero, -5 rpm

(B) zero, 955 rpm

(C) 1000 rpm, -5 rpm

(D) 1000 rpm, 955 rpm

Q.40 A capacitor is made with a polymeric dielectric having an ϵ_r of 2.26 and a dielectric breakdown strength of 50 kV/cm. The permittivity of free space is 8.85 pF/m. If the rectangular plates of the capacitor have a width of 20 cm and a length of 40 cm, then the maximum electric charge in the capacitor is

(A) 2 μC

(B) 4 μC

(C) 8 μC

(D) 10 μC

Q.41 The response $h(t)$ of a linear time invariant system to an impulse $\delta(t)$, under initially relaxed condition is $h(t) = e^{-t} + e^{-2t}$. The response of this system for a unit step input $u(t)$ is

(A) $u(t) + e^{-t} + e^{-2t}$

(B) $(e^{-t} + e^{-2t})u(t)$

(C) $(1.5 - e^{-t} - 0.5e^{-2t})u(t)$

(D) $e^{-t}\delta(t) + e^{-2t}u(t)$

Q.42 The direct axis and quadrature axis reactances of a salient pole alternator are 1.2 p.u and 1.0 p.u respectively. The armature resistance is negligible. If this alternator is delivering rated kVA at upf and at rated voltage then its power angle is

(A) 30°

(B) 45°

(C) 60°

(D) 90°

Q.43 A 4½ digit DMM has the error specification as: 0.2 % of reading + 10 counts. If a dc voltage of 100 V is read on its 200 V full scale, the maximum error that can be expected in the reading is

- (A) $\pm 0.1\%$ (B) $\pm 0.2\%$ (C) $\pm 0.3\%$ (D) $\pm 0.4\%$

Q.44 A three-bus network is shown in the figure below indicating the p.u. impedances of each element.

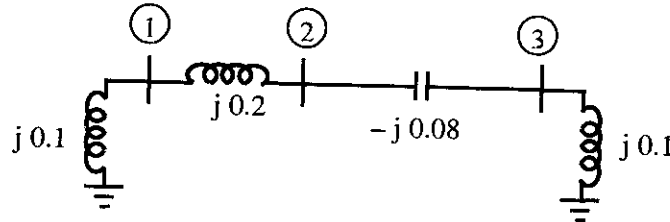

The Bus admittance matrix, Y-bus, of the network is

- (A) $j \begin{bmatrix} 0.3 & -0.2 & 0 \\ -0.2 & 0.12 & 0.08 \\ 0 & 0.08 & 0.02 \end{bmatrix}$ (B) $j \begin{bmatrix} -15 & 5 & 0 \\ 5 & 7.5 & -12.5 \\ 0 & -12.5 & 2.5 \end{bmatrix}$
- (C) $j \begin{bmatrix} 0.1 & 0.2 & 0 \\ 0.2 & 0.12 & -0.08 \\ 0 & -0.08 & 0.10 \end{bmatrix}$ (D) $j \begin{bmatrix} -10 & 5 & 0 \\ 5 & 7.5 & 12.5 \\ 0 & 12.5 & -10 \end{bmatrix}$

Q.45 A two-loop position control system is shown below.

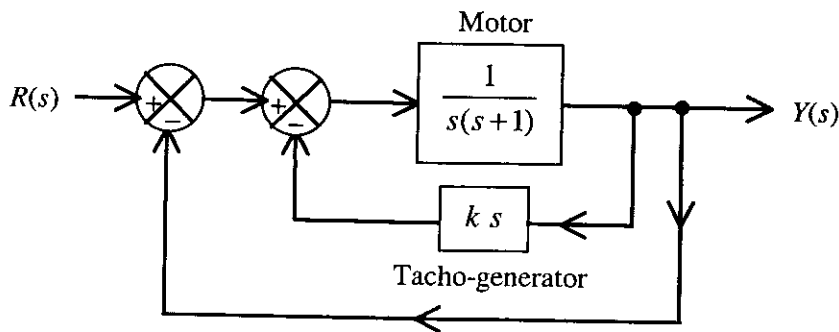

The gain k of the Tacho-generator influences mainly the

- (A) peak overshoot
 (B) natural frequency of oscillation
 (C) phase shift of the closed loop transfer function at very low frequencies ($\omega \rightarrow 0$)
 (D) phase shift of the closed loop transfer function at very high frequencies ($\omega \rightarrow \infty$)

Q.46 A two-bit counter circuit is shown below.

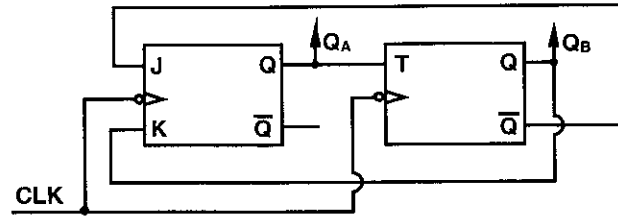

If the state $Q_A Q_B$ of the counter at the clock time t_n is "10" then the state $Q_A Q_B$ of the counter at t_n+3 (after three clock cycles) will be

- (A) 00
- (B) 01
- (C) 10
- (D) 11

Q.47 A clipper circuit is shown below.

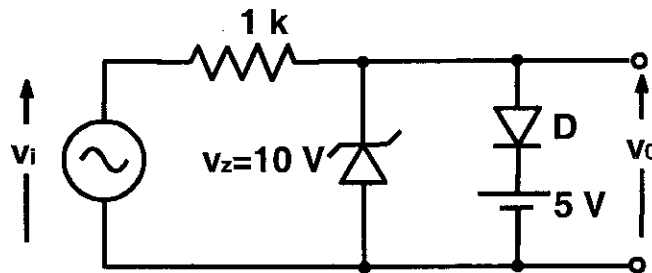

Assuming forward voltage drops of the diodes to be 0.7 V, the input-output transfer characteristics of the circuit is

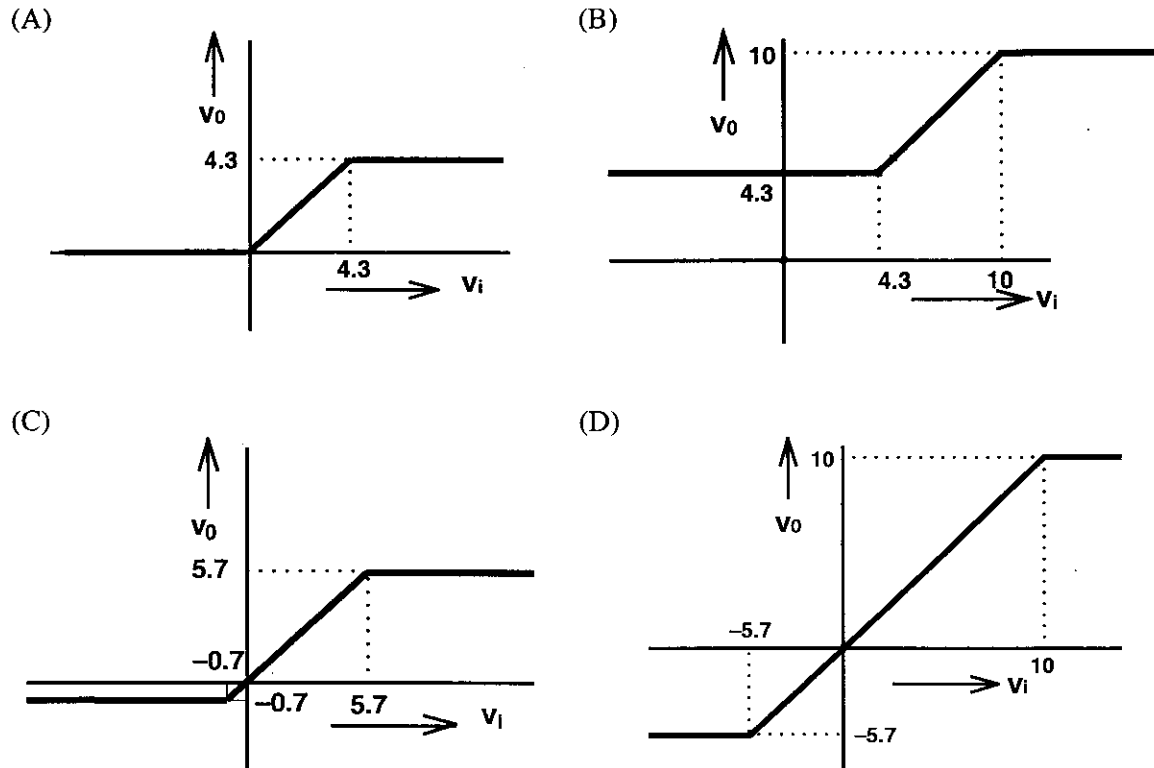

Common Data Questions

Common Data for Questions 48 and 49:

The input voltage given to a converter is

$$v_i = 100\sqrt{2} \sin(100\pi t) \text{ V}$$

The current drawn by the converter is

$$i_i = \left(10\sqrt{2} \sin(100\pi t - \pi/3) + 5\sqrt{2} \sin(300\pi t + \pi/4) + 2\sqrt{2} \sin(500\pi t - \pi/6)\right) \text{ A}$$

Q.48 The input power factor of the converter is

- (A) 0.31 (B) 0.44 (C) 0.5 (D) 0.71

Q.49 The active power drawn by the converter is

- (A) 181 W (B) 500 W (C) 707 W (D) 887 W

Common Data for Questions 50 and 51:

An RLC circuit with relevant data is given below.

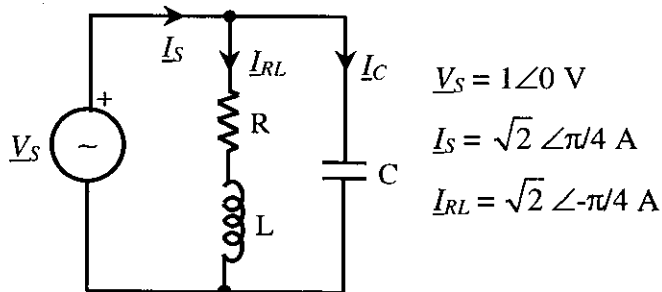

Q.50 The power dissipated in the resistor R is

- (A) 0.5 W (B) 1 W (C) $\sqrt{2}$ W (D) 2 W

Q.51 The current \underline{I}_C in the figure above is

- (A) $-j 2 \text{ A}$ (B) $-j \frac{1}{\sqrt{2}} \text{ A}$ (C) $+j \frac{1}{\sqrt{2}} \text{ A}$ (D) $+j 2 \text{ A}$

Linked Answer Questions

Statement for Linked Answer Questions 52 and 53:

Two generator units G1 and G2 are connected by 15 kV line with a bus at the mid-point as shown below.

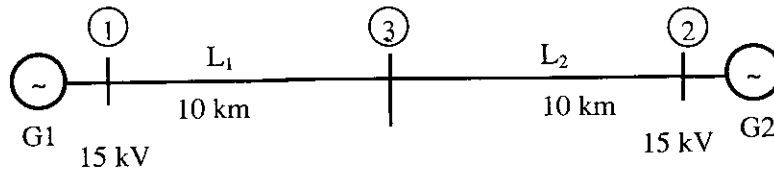

G1 = 250 MVA, 15 kV, positive sequence reactance $X = 25\%$ on its own base

G2 = 100 MVA, 15 kV, positive sequence reactance $X = 10\%$ on its own base

L_1 and $L_2 = 10$ km, positive sequence reactance $X = 0.225 \Omega/\text{km}$

Q.52 For the above system, the positive sequence diagram with the p.u values on the 100 MVA common base is

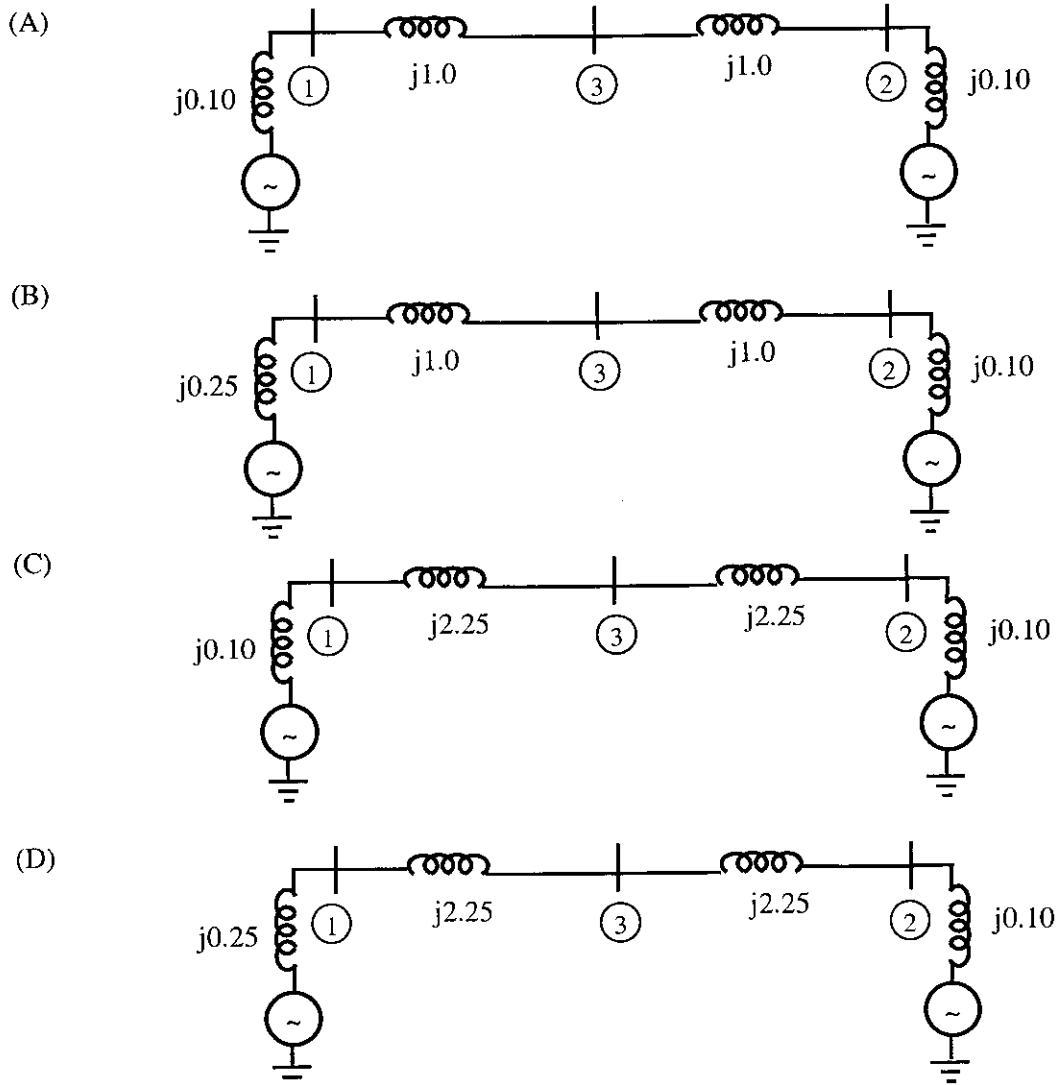

Q.53 In the above system, the three-phase fault MVA at the bus 3 is

- (A) 82.55 MVA (B) 85.11 MVA (C) 170.91 MVA (D) 181.82 MVA

Statement for Linked Answer Questions 54 and 55:

A solar energy installation utilizes a three-phase bridge converter to feed energy into power system through a transformer of 400 V/ 400 V, as shown below.

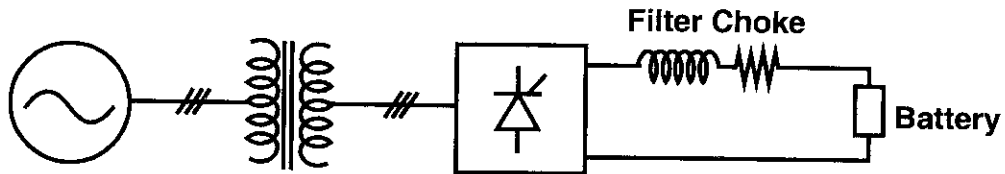

The energy is collected in a bank of 400 V battery and is connected to converter through a large filter choke of resistance $10\ \Omega$.

Q.54 The maximum current through the battery will be

- (A) 14 A (B) 40 A (C) 80 A (D) 94 A

Q.55 The kVA rating of the input transformer is

- (A) 53.2 kVA (B) 46.0 kVA (C) 22.6 kVA (D) 19.6 kVA

General Aptitude (GA) Questions**Q. 56 – Q. 60 carry one mark each.**

Q.56 Choose the most appropriate word from the options given below to complete the following sentence:

Under ethical guidelines recently adopted by the Indian Medical Association, human genes are to be manipulated only to correct diseases for which _____ treatments are unsatisfactory.

- (A) similar
- (B) most
- (C) uncommon
- (D) available

Q.57 The question below consists of a pair of related words followed by four pairs of words. Select the pair that best expresses the relation in the original pair:

Gladiator : Arena

- (A) dancer : stage
- (B) commuter : train
- (C) teacher : classroom
- (D) lawyer : courtroom

Q.58 There are two candidates P and Q in an election. During the campaign, 40% of the voters promised to vote for P, and rest for Q. However, on the day of election 15% of the voters went back on their promise to vote for P and instead voted for Q. 25% of the voters went back on their promise to vote for Q and instead voted for P. Suppose, P lost by 2 votes, then what was the total number of voters?

- (A) 100
- (B) 110
- (C) 90
- (D) 95

Q.59 Choose the most appropriate word from the options given below to complete the following sentence:

It was her view that the country's problems had been _____ by foreign technocrats, so that to invite them to come back would be counter-productive.

- (A) identified
- (B) ascertained
- (C) exacerbated
- (D) analysed

Q.60 Choose the word from the options given below that is most nearly opposite in meaning to the given word:

Frequency

- (A) periodicity
- (B) rarity
- (C) gradualness
- (D) persistency

Q. 61 to Q. 65 carry two marks each.

Q.61 The sum of n terms of the series $4+44+444+\dots$ is

- (A) $(4/81) [10^{n+1} - 9n - 1]$
- (B) $(4/81) [10^{n-1} - 9n - 1]$
- (C) $(4/81) [10^{n+1} - 9n - 10]$
- (D) $(4/81) [10^n - 9n - 10]$

Q.62 The horse has played a little known but very important role in the field of medicine. Horses were injected with toxins of diseases until their blood built up immunities. Then a serum was made from their blood. Serums to fight with diphtheria and tetanus were developed this way.

It can be inferred from the passage, that horses were

- (A) given immunity to diseases
- (B) generally quite immune to diseases
- (C) given medicines to fight toxins
- (D) given diphtheria and tetanus serums

Q.63 The fuel consumed by a motorcycle during a journey while traveling at various speeds is indicated in the graph below.

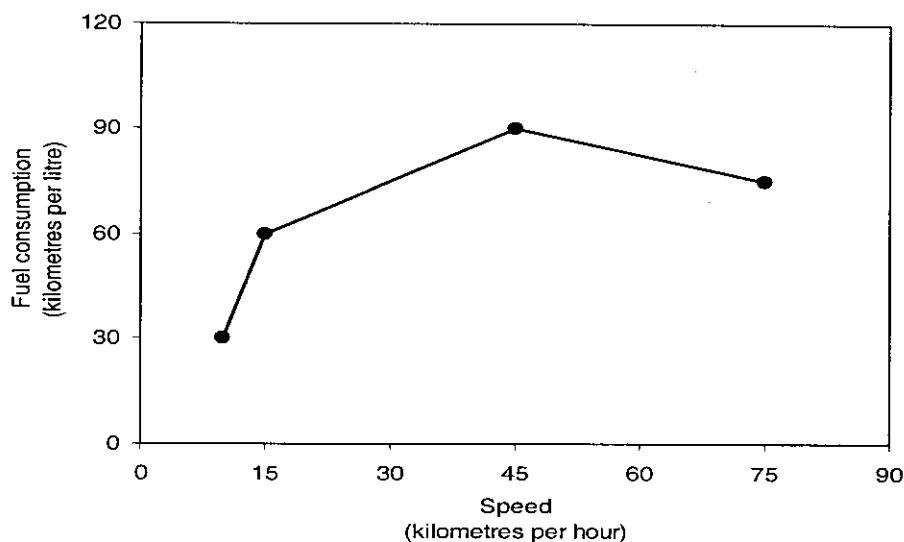

The distances covered during four laps of the journey are listed in the table below

Lap	Distance (kilometres)	Average speed (kilometres per hour)
P	15	15
Q	75	45
R	40	75
S	10	10

From the given data, we can conclude that the fuel consumed per kilometre was least during the lap

- (A) P
- (B) Q
- (C) R
- (D) S

Q.64 Three friends, R, S and T shared toffee from a bowl. R took $\frac{1}{3}^{\text{rd}}$ of the toffees, but returned four to the bowl. S took $\frac{1}{4}^{\text{th}}$ of what was left but returned three toffees to the bowl. T took half of the remainder but returned two back into the bowl. If the bowl had 17 toffees left, how many toffees were originally there in the bowl?

- (A) 38
- (B) 31
- (C) 48
- (D) 41

Q.65 Given that $f(y) = |y| / y$, and q is any non-zero real number, the value of $|f(q) - f(-q)|$ is

- (A) 0
- (B) -1
- (C) 1
- (D) 2

END OF THE QUESTION PAPER